

IZAGA

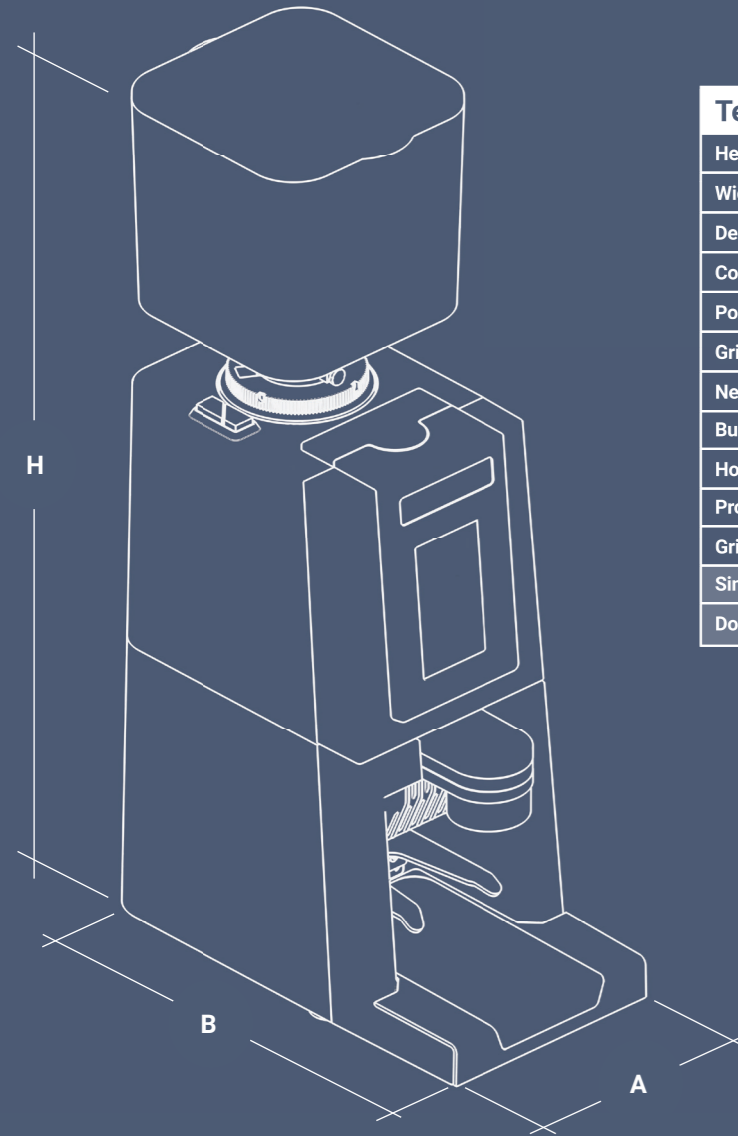

Technical Specifications	EN
Height (H)	640 mm / 7 inches
Width (A)	180 mm / 13 3/4 inches
Depth (B)	352 mm / 25 1/4 inches
Connected load	230 V - 50 Hz
Power	525 W
Grinding burrs speed	1350 rpm
Net weight	16 kg
Burrs	Ø 64 mm. Plain
Hopper capacity	1,5 kg / 3,3 lb
Production per hour	8 kg/h
Grinder capacity	4 g/s
Single dose	5 - 18 g
Double dose	5 - 28 g

Discover our products

The ideal automatic coffee grinders for your Horeca business

Convenience, robustness, easy to maintain, easy to clean and dosage accuracy. Those are some of the features of the **MARKIBAR** coffee grinders.

In addition to **IZAGA**, we complete the **MARKIBAR** professional grinders range with the **QUIMBOA** and **ASPE** models.

QUIMBOA



Efficiency from the first to the last coffee cup.

The compact and robust design of the **QUIMBOA** automatic coffee grinder offers maximum performance and efficiency to meet the needs of the Horeca's professional.

ASPE



As versatile as your demands.

The **ASPE** professional coffee grinder is specifically designed for the baristas. It adapts to all your grinding needs, from special coffees to rush hours working.

IZAGA

High consistency in each cup of coffee



The new **IZAGA** coffee grinder combines innovation, advanced technology and a modern aesthetic to offer a professional and precise automatic grinder that responds to the requirements of a high coffee consumption customers.

mar **K**ibar

More than 30 years of R&D at the service of coffee professionals

MARKIBAR is a leading company in Research, Design, Development and Manufacture of automatic coffee grinders for the **HORECA** professionals.

For 30 years, we have worked to offer our customers innovative solutions to guarantee the coffee's quality in each cup.

We bring all our experience and passion for innovation to create automatic coffee grinders, who make the work of the Horeca professional easier.

We manufacture our products with local suppliers, guaranteeing quality, reliability and service from our facilities located in North of Spain.



Polígono Industrial NOÁIN-ESQUIROZ.
C/ G. Nave 39. 31191 Esquiroz, Navarra (Spain)
+34 948 317 906
info@markibar.com
www.markibar.com

mar **K**ibar

Its isolated grinding chamber, smart ventilation, innovative grinding point control system and its top quality materials, are designed for highly demanding coffee shops with a high coffee consumption.

High consistency in each cup of coffee

IZAGA

mar **K**ibar

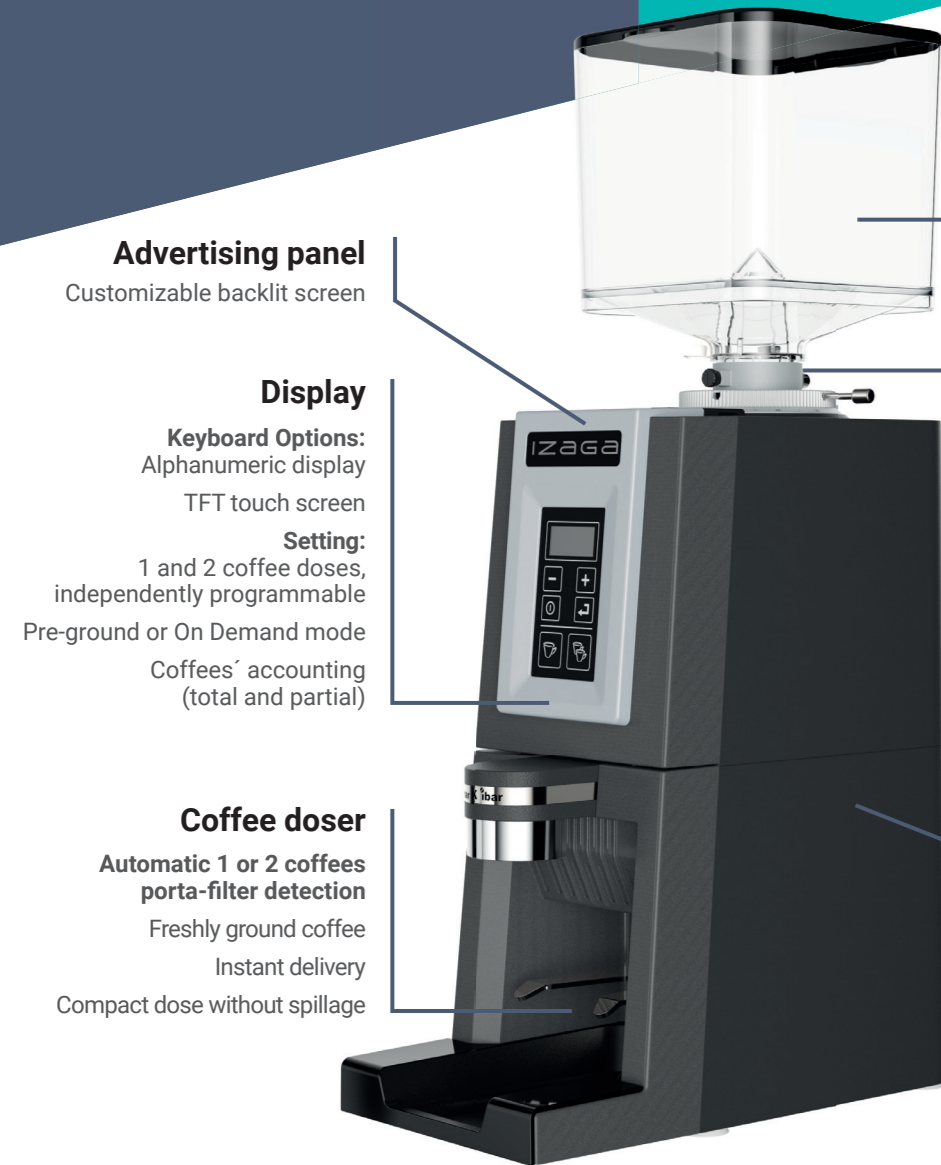

Hopper
1,500 g hopper
Anti-rotation system
Customizable
Easy extraction for cleaning

Technology
Isolated grinding chamber
Grinding parameter stability guaranteed
Smart ventilation
Long-life burrs
High reliability design

Design
Easy access for maintenance
Modern and functional aesthetics
High quality materials

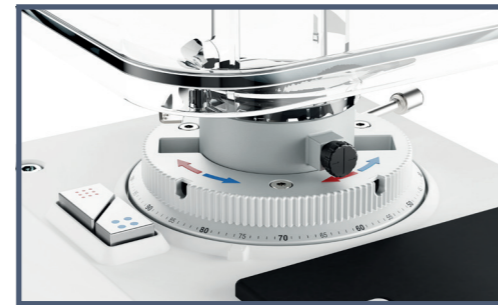
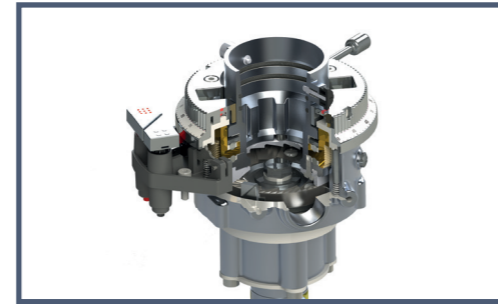

Isolated grinding chamber and smart ventilation

The IZAGA automatic coffee grinder has the most advanced technology to guarantee its high performance.

The design of the independent grinding chamber, thermally isolated from drive motor allows cold grinding, even for large coffee consumption.

High precision grinding point control

IZAGA allows you to regulate the required coffee grinding point with micrometric precision.

Each CLICK of the grinding point modifies the particle size by 0.0083 mm/click. In addition, the bidirectional handle locking system, which requires the Coarse or Fine key to be pressed to start, allows for error-free adjustment of the grinding point in the proper direction.

Working modes

ON DEMAND

Maximum freshness of freshly ground coffee.

On mode On Demand IZAGA, coffee is ground when the 1 or 2 coffee porta-filter requests it.

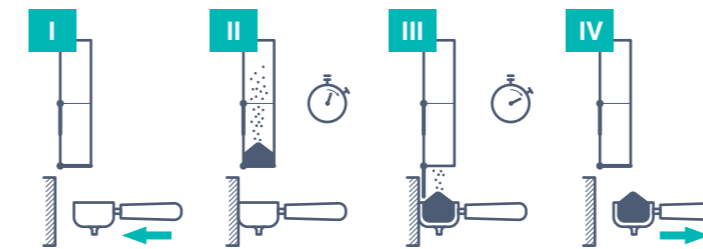

PRE-GROUND

Maximum performance for rush hours.

On mode Pre-Ground IZAGA, 1 or 2 coffee doses are available in the grinder doser. When the porta filter requests it, the dose is delivered instantly.

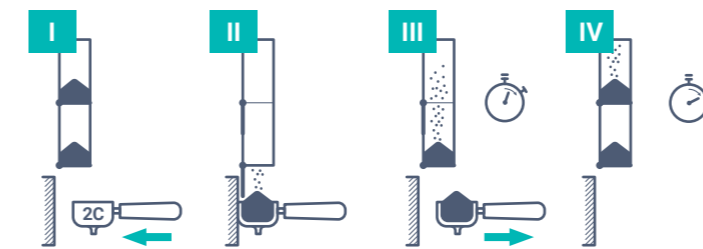

Colour

Choose the colour of your IZAGA professional coffee grinder from these two combinations: **White / Aluminium**, for a modern and striking style. **Black / Anthracite**, for a more discreet and smart style.



WHITE / ALUMINIUM



BLACK / ANTHRACITE

Customization

IZAGA allows you to customize your grinder to promote your brand.

The hopper design provides a highly visible advertising space to promote the desired brand. There is also the possibility of adding advertising on the backlit panel at the front.

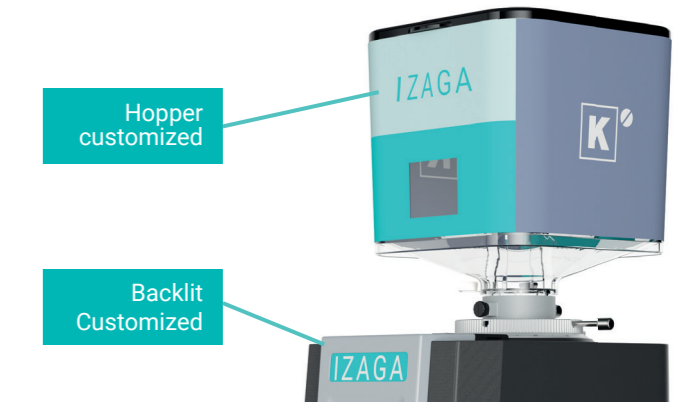

Hopper customized

Backlit Customized

Barista option

IZAGA is available with and without tamper, according to your preferences.

The standard grinder is supplied with a 57 mm and 53 mm diameter tamper.

There is also the option of a coffee grinder without a fixed tamper, to be used by external tamper.



Fixed tamper



No tamper

Online Management (optional)

Check the performance data of your IZAGA remotely.

IZAGA completes its features with the option of an online management system to know the coffee grinder information anywhere, anytime via your computer, tablet or smartphone.

